

C122F1, C122B1

Silicon Controlled Rectifiers

Reverse Blocking Thyristors

Designed primarily for full-wave ac control applications, such as motor controls, heating controls and power supplies; or wherever half-wave silicon gate-controlled, solid-state devices are needed.

Features

- Glass Passivated Junctions and Center Gate Fire for Greater Parameter Uniformity and Stability
- Small, Rugged, Thermowatt Construction for Low Thermal Resistance, High Heat Dissipation and Durability
- Blocking Voltage to 200 Volts
- Pb-Free Packages are Available*

MAXIMUM RATINGS ($T_J = 25^\circ\text{C}$ unless otherwise noted)

Rating	Symbol	Value	Unit
Peak Repetitive Off-State Voltage (Note 1) ($T_J = 25$ to 100°C , Sine Wave, 50 to 60 Hz; Gate Open)	V_{DRM} , V_{RRM}	50 200	V
On-State RMS Current (180° Conduction Angles; $T_C = 75^\circ\text{C}$)	$I_{\text{T(RMS)}}$	8.0	A
Peak Non-Repetitive Surge Current (1/2 Cycle, Sine Wave, 60 Hz, $T_C = 75^\circ\text{C}$)	I_{TSM}	90	A
Circuit Fusing Considerations ($t = 8.3$ ms)	I^2t	34	A^2s
Forward Peak Gate Power (Pulse Width = $10 \mu\text{s}$, $T_C = 70^\circ\text{C}$)	P_{GM}	5.0	W
Forward Average Gate Power ($t = 8.3$ ms, $T_C = 70^\circ\text{C}$)	$P_{\text{G(AV)}}$	0.5	W
Forward Peak Gate Current (Pulse Width = $10 \mu\text{s}$, $T_C = 70^\circ\text{C}$)	I_{GM}	2.0	A
Operating Junction Temperature Range	T_J	-40 to +125	$^\circ\text{C}$
Storage Temperature Range	T_{stg}	-40 to +150	$^\circ\text{C}$

Maximum ratings are those values beyond which device damage can occur. Maximum ratings applied to the device are individual stress limit values (not normal operating conditions) and are not valid simultaneously. If these limits are exceeded, device functional operation is not implied, damage may occur and reliability may be affected.

1. V_{DRM} and V_{RRM} for all types can be applied on a continuous basis. Ratings apply for zero or negative gate voltage; however, positive gate voltage shall not be applied concurrent with negative potential on the anode. Blocking voltages shall not be tested with a constant current source such that the voltage ratings of the devices are exceeded.

*For additional information on our Pb-Free strategy and soldering details, please download the ON Semiconductor Soldering and Mounting Techniques Reference Manual, SOLDERRM/D.



ON Semiconductor®

<http://onsemi.com>

SCRs
8 AMPERES RMS
50 thru 200 VOLTS

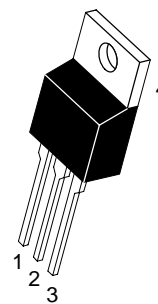

MARKING DIAGRAM

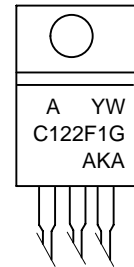

TO-220AB
CASE 221A
STYLE 3

A = Assembly Location
Y = Year
W = Work Week
C122F1 = Device Code
G = Pb-Free Package
AKA = Diode Polarity

PIN ASSIGNMENT

Pin	Assignment
1	Cathode
2	Anode
3	Gate
4	Anode

ORDERING INFORMATION

Device	Package	Shipping
C122F1	TO220AB	500 Units / Box
C122F1G	TO220AB (Pb-Free)	500 Units / Box
C122B1	TO220AB	500 Units / Box
C122B1G	TO220AB (Pb-Free)	500 Units / Box

C122F1, C122B1

THERMAL CHARACTERISTICS

Characteristic	Symbol	Max	Unit
Thermal Resistance, Junction-to-Case	$R_{\theta JC}$	1.8	$^{\circ}C/W$
Thermal Resistance, Junction-to-Ambient	$R_{\theta JA}$	62.5	$^{\circ}C/W$
Maximum Lead Temperature for Soldering Purposes 1/8 in. from Case for 10 Seconds	T_L	260	$^{\circ}C$

ELECTRICAL CHARACTERISTICS ($T_C = 25^{\circ}C$ unless otherwise noted.)

Characteristic	Symbol	Min	Typ	Max	Unit
----------------	--------	-----	-----	-----	------

OFF CHARACTERISTICS

Peak Repetitive Forward or Reverse Blocking Current ($V_{AK} = \text{Rated } V_{DRM} \text{ or } V_{RRM}, \text{ Gate Open}$)	I_{DRM}, I_{RRM}	-	-	10	μA
$T_C = 25^{\circ}C$		-	-		
$T_C = 125^{\circ}C$		-	-	0.5	mA

ON CHARACTERISTICS

Peak On-State Voltage (Note 2) ($I_{TM} = 16 \text{ A Peak}, T_C = 25^{\circ}C$)	V_{TM}	-	-	1.83	V
Gate Trigger Current (Continuous dc) ($V_{AK} = 12 \text{ V}, R_L = 100 \Omega$)	I_{GT}	-	-	25	mA
$T_C = 25^{\circ}C$		-	-		
$T_C = -40^{\circ}C$		-	-	40	
Gate Trigger Voltage (Continuous dc) ($V_{AK} = 12 \text{ V}, R_L = 100 \Omega$)	V_{GT}	-	-	1.5	V
$T_C = 25^{\circ}C$		-	-		
$T_C = -40^{\circ}C$		-	-	2.0	
Gate Non-Trigger Voltage (Continuous dc) ($V_{AK} = 12 \text{ V}, R_L = 100 \Omega, T_C = 125^{\circ}C$)	V_{GD}	0.2	-	-	V
Holding Current ($V_{AK} = 12 \text{ Vdc}, \text{ Initiating Current} = 200 \text{ mA}, \text{ Gate Open}$)	I_H	-	-	30	mA
$T_C = 25^{\circ}C$		-	-		
$T_C = -40^{\circ}C$		-	-	60	
Turn-Off Time ($V_D = \text{Rated } V_{DRM}$) ($I_{TM} = 8 \text{ A}, I_R = 8 \text{ A}$)	t_q	-	50	-	μs

DYNAMIC CHARACTERISTICS

Critical Rate-of-Rise of Off-State Voltage ($V_{AK} = \text{Rated } V_{DRM}, \text{ Exponential Waveform}, \text{ Gate Open}, T_C = 100^{\circ}C$)	dv/dt	-	50	-	V/ μs
---	-------	---	----	---	------------

2. Pulse Test: Pulse Width $\leq 1 \text{ ms}$, Duty Cycle $\leq 2\%$.

Voltage Current Characteristic of SCR

Symbol	Parameter
V_{DRM}	Peak Repetitive Off State Forward Voltage
I_{DRM}	Peak Forward Blocking Current
V_{RRM}	Peak Repetitive Off State Reverse Voltage
I_{RRM}	Peak Reverse Blocking Current
V_{TM}	Peak On State Voltage
I_H	Holding Current

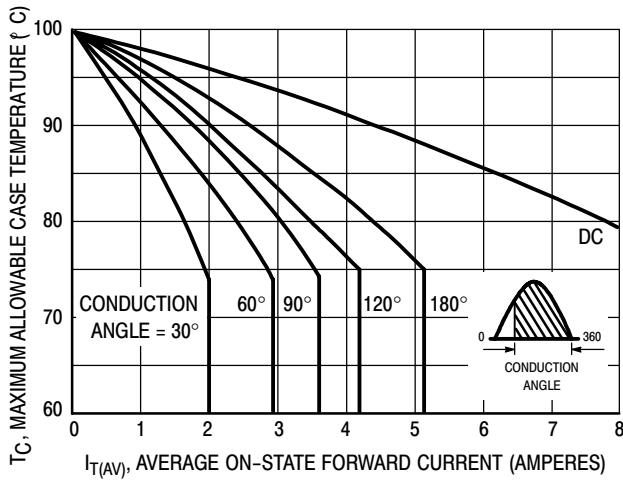
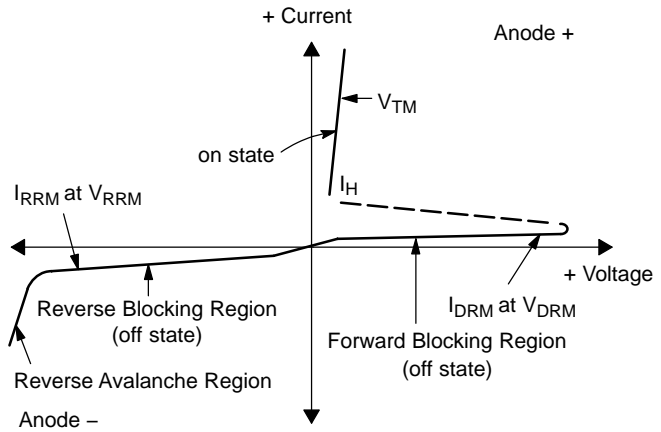

Figure 1. Current Derating (Half-Wave)

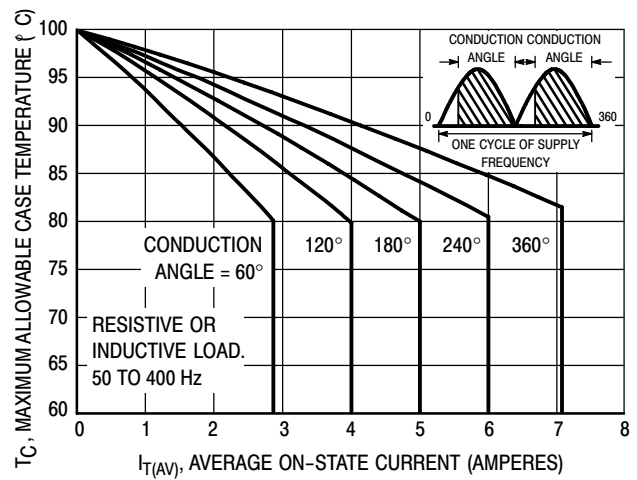

Figure 2. Current Derating (Full-Wave)

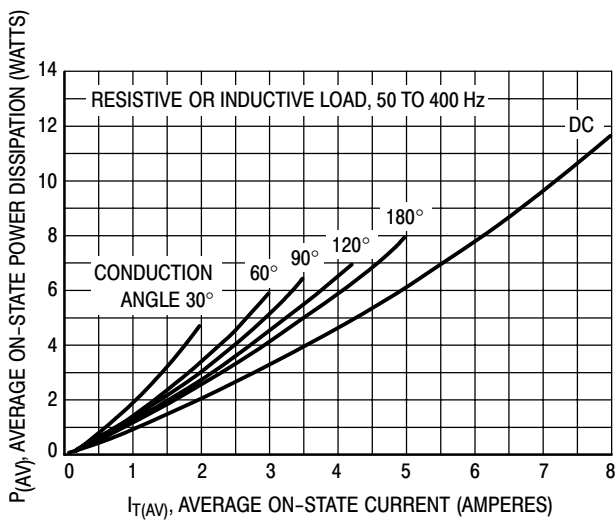

Figure 3. Maximum Power Dissipation (Half-Wave)

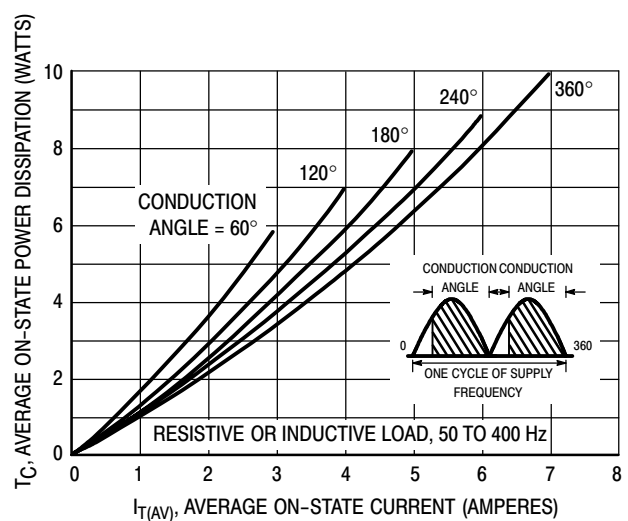
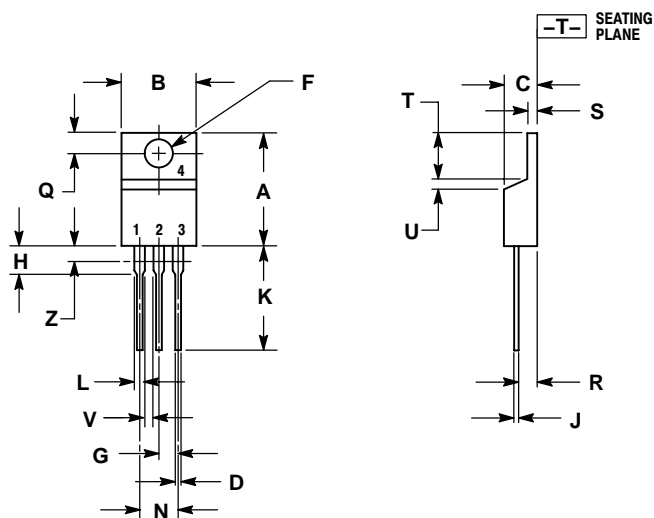

Figure 4. Maximum Power Dissipation (Full-Wave)

C122F1, C122B1

PACKAGE DIMENSIONS

TO-220AB
CASE 221A-07
ISSUE AA



- NOTES:
1. DIMENSIONING AND TOLERANCING PER ANSI Y14.5M, 1982.
 2. CONTROLLING DIMENSION: INCH.
 3. DIMENSION Z DEFINES A ZONE WHERE ALL BODY AND LEAD IRREGULARITIES ARE ALLOWED.

DIM	INCHES		MILLIMETERS	
	MIN	MAX	MIN	MAX
A	0.570	0.620	14.48	15.75
B	0.380	0.405	9.66	10.28
C	0.160	0.190	4.07	4.82
D	0.025	0.035	0.64	0.88
F	0.142	0.147	3.61	3.73
G	0.095	0.105	2.42	2.66
H	0.110	0.155	2.80	3.93
J	0.014	0.022	0.36	0.55
K	0.500	0.562	12.70	14.27
L	0.045	0.060	1.15	1.52
N	0.190	0.210	4.83	5.33
Q	0.100	0.120	2.54	3.04
R	0.080	0.110	2.04	2.79
S	0.045	0.055	1.15	1.39
T	0.235	0.255	5.97	6.47
U	0.000	0.050	0.00	1.27
V	0.045	---	1.15	---
Z	---	0.080	---	2.04

- STYLE 3:
PIN 1. CATHODE
2. ANODE
3. GATE
4. ANODE

ON Semiconductor and are registered trademarks of Semiconductor Components Industries, LLC (SCILLC). SCILLC reserves the right to make changes without further notice to any products herein. SCILLC makes no warranty, representation or guarantee regarding the suitability of its products for any particular purpose, nor does SCILLC assume any liability arising out of the application or use of any product or circuit, and specifically disclaims any and all liability, including without limitation special, consequential or incidental damages. "Typical" parameters which may be provided in SCILLC data sheets and/or specifications can and do vary in different applications and actual performance may vary over time. All operating parameters, including "Typicals" must be validated for each customer application by customer's technical experts. SCILLC does not convey any license under its patent rights nor the rights of others. SCILLC products are not designed, intended, or authorized for use as components in systems intended for surgical implant into the body, or other applications intended to support or sustain life, or for any other application in which the failure of the SCILLC product could create a situation where personal injury or death may occur. Should Buyer purchase or use SCILLC products for any such unintended or unauthorized application, Buyer shall indemnify and hold SCILLC and its officers, employees, subsidiaries, affiliates, and distributors harmless against all claims, costs, damages, and expenses, and reasonable attorney fees arising out of, directly or indirectly, any claim of personal injury or death associated with such unintended or unauthorized use, even if such claim alleges that SCILLC was negligent regarding the design or manufacture of the part. SCILLC is an Equal Opportunity/Affirmative Action Employer. This literature is subject to all applicable copyright laws and is not for resale in any manner.

PUBLICATION ORDERING INFORMATION

LITERATURE FULFILLMENT:
Literature Distribution Center for ON Semiconductor
P.O. Box 61312, Phoenix, Arizona 85082-1312 USA
Phone: 480-829-7710 or 800-344-3860 Toll Free USA/Canada
Fax: 480-829-7709 or 800-344-3867 Toll Free USA/Canada
Email: orderlit@onsemi.com

N. American Technical Support: 800-282-9855 Toll Free
USA/Canada

Japan: ON Semiconductor, Japan Customer Focus Center
2-9-1 Kamimeguro, Meguro-ku, Tokyo, Japan 153-0051
Phone: 81-3-5773-3850

ON Semiconductor Website: <http://onsemi.com>

Order Literature: <http://www.onsemi.com/litorder>

For additional information, please contact your local Sales Representative.